



Access Hardware Ltd

Stainless Steel Cubicle Hardware
—— *Glass Cubicles* ——



Stylishly Simple

PRODUCT | RANGE

Stylishly Simple



Introduction

At Access Hardware we aim to provide quality products at an affordable price. The stainless steel products in this range are designed for use with glass cubicles.

Material

All products in this range are satin stainless steel finish

SSS 316 – A higher grade of stainless steel for improved corrosion resistance

SSS Permalast – A special coating to improve the corrosion resistance of the Stainless Steel Material

Guarantee

Access Hardware guarantees their products against defects in workmanship and materials subject to fair wear and tear in standard atmospheric conditions for a period of 10 years.

Access Hardware assumes no liability for:

- Improper installation or failure to follow fitting instructions.
- Improper maintenance or unfair wear and tear.
- Indirect or consequential loss or damage.
- Cost of removal and/or replacement.
- Cost of freight and/or travelling expenses.

Although our stainless steel products are suitable for most applications, neither grade 316 or permalast is unconditionally guaranteed and advice should be sought from one of our representatives.

Care and Maintenance

To retain the highest corrosion resistance it is necessary to keep the surface of stainless steel clean. This can be done by wiping with a warm clean cloth using either a mild detergent or soap, then rinsing with warm clean water and drying with a towel. Carbon steel brushes or wire wool should not be used. Comprehensive instructions are available upon request.

Change of product specification

As a result of continuous improvements to our products, we reserve the right to alter standard product specifications and dimensions without prior notice.

Indicator

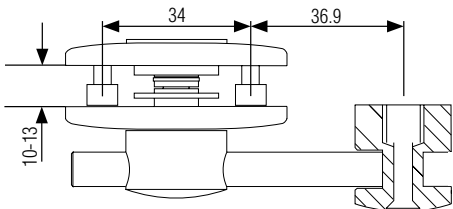

T203SM Indicator Turn and keep

Suitable for 10mm glass and 13mm flush systems
Bolt through fixings supplied

T203SM/F1

Extension keep available for 10mm glass and
13mm overlapping systems, supplied separately

Finish: SSS Permalast

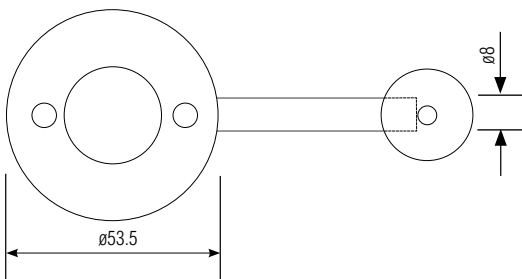

overlapping system

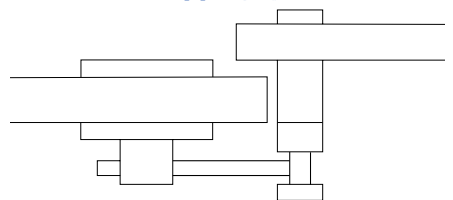



T113SM Glass Patch fitting heavy duty hinge pair

Available in Left or Right hand

Suitable for 10mm glass and 13mm
overlapping systems

Can be adjusted to fall open or fall closed

Fixings supplied

Finish: SSS Grade 316

chart of handing for hinges

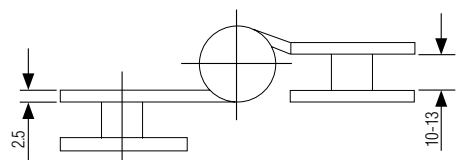
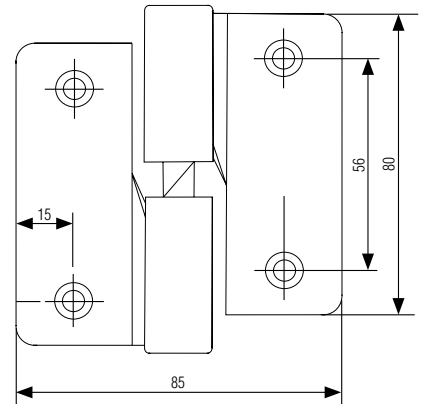
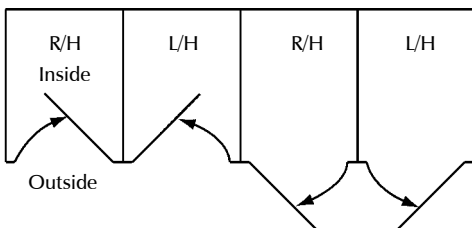

Bracket



T403SM Glass Patch Bracket

Suitable for 10mm glass and 13mm board
Glass and wall fixings supplied
Finish: SSS Permalast

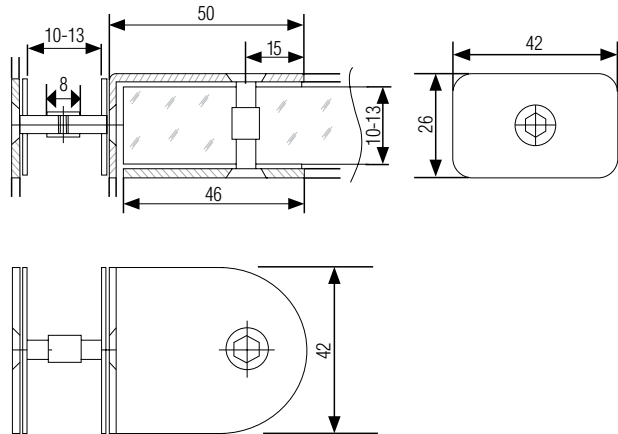

T503SM Patch Fitting Coat Hook

Suitable for 10mm glass and 13mm board
Bolt through disc supplied
Finish: SSS Permalast

T351SM Dome Foot Support

Suitable for 10-32mm board
Adjustable from 85-115mm
Bolt through fixings and T nuts supplied
Finish: SSS 316

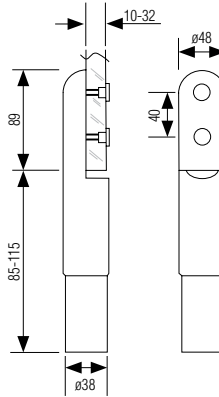

T352SM Dome Foot Support

Suitable for 10mm-32mm board
Adjustable from 135-165mm
Bolt through fixings and T nuts supplied
Finish: SSS 316

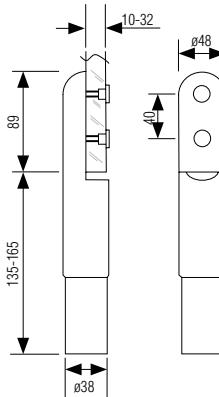

T352SM/F1

Patch fitting plate for glass
Finish: SSS 316

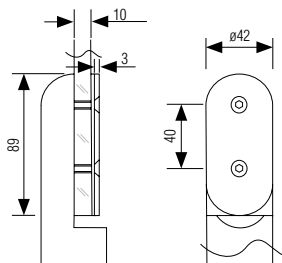

N.B. These images are for illustration purposes only

Headrail



T900SM
32mm dia Tube Headrail,
3 meter length

Finish: SSS 316

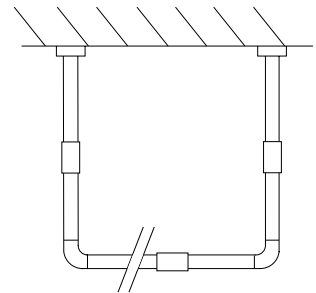
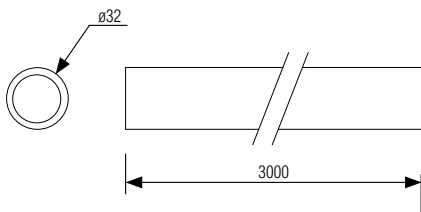

Single Wall Arrangement

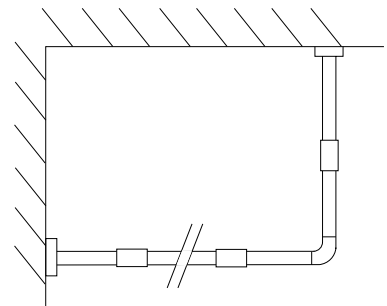

Corner Wall Arrangement

T900SM/F1

Headrail Fixing Clamp

Suitable for 10mm glass and 13mm board

Fixings supplied

Finish: SSS Permalast



T900SM/F2

Headrail End Rose

Nylon inner rose, concealed fix

Wall fixings supplied

Finish: SSS Permalast



Headrail

T900SM/F3

Headrail Corner Joint

Finish: SSS Permalast



T900SM/F4

Headrail 'T' Joint

Finish: SSS Permalast





Stylishly Simple



Access Hardware Ltd

Green Lane | Studley | Warwickshire | B80 7EY

Tel: 01527 852 948 | Fax: 01527 854 192

Email: sales@accesshardware.co.uk
www.accesshardware.co.uk

Contact Distributor