

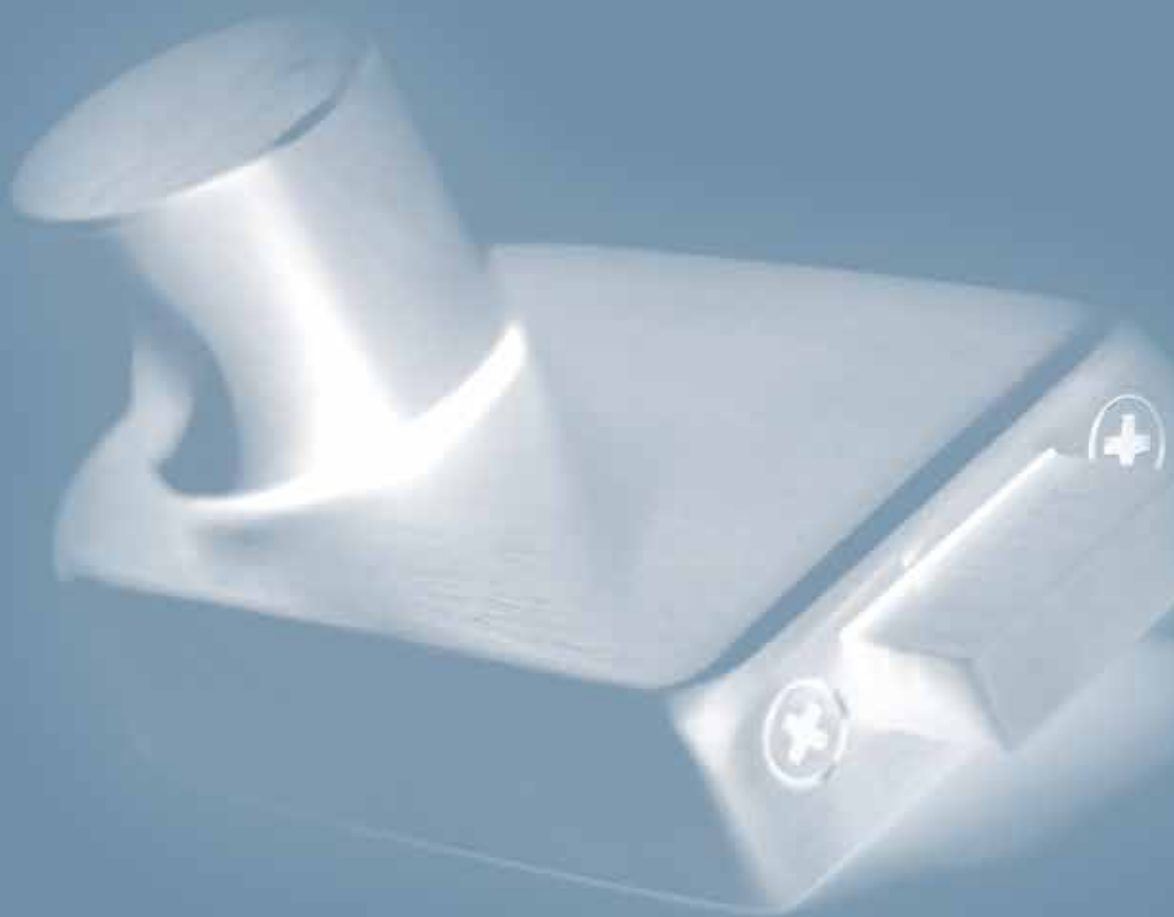

Access Hardware Ltd

Stainless Steel Cubicle Hardware



Stylishly Simple

PRODUCT | RANGE

Access Hardware is an innovative company dedicated to manufacturing and supplying architectural hardware to the construction markets.

Products offered include a broad range of door and toilet cubicle hardware predominantly in stainless steel.

Material

All products are manufactured from grade 304 stainless steel or Aluminium.

Standard grade 304 stainless steel is both strong and corrosion resistant. It is suitable for most applications.

Marine grade 316 stainless steel having better corrosion resistance is recommended for polluted, coastal or chloride environments such as swimming pools.

Finish

- SSS - Satin Stainless Steel (Brushed finish)
- PSS - Polished Stainless Steel (Mirror finish)
- SAA – Satin Anodised Aluminium
- PAA – Polished Anodised Aluminium

Specials

Security fixings are available as an extra with most products.

Uniquely designed products not included in our standard range can be manufactured to customer's own specification.

Handing

- L/H - Left Hand
- R/H - Right hand

Installation of Products

- Open in door
- L shaped Keep
- 8mm buffer

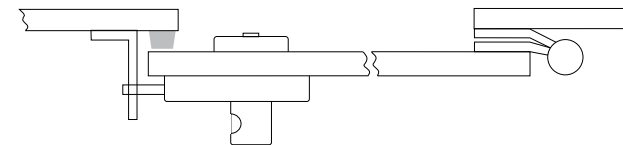

- Open out door
- U shaped Keep
- 15mm buffer

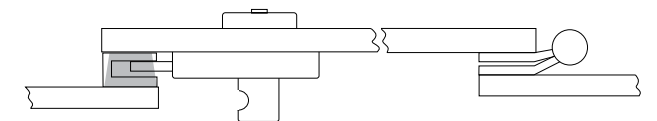

- Open in door
- Deluxe Box Keep

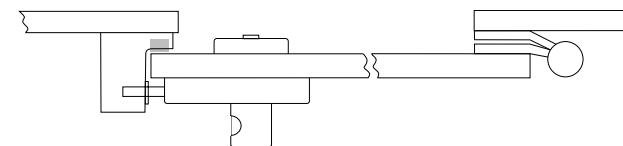

- Flush door
- U shaped Keep

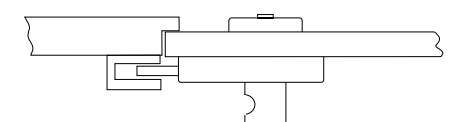

Indicator Bolts



T200 – Indicator Bolt

Suitable for 13mm and 20mm board

Concealed bolt through fixings supplied

Keep supplied separately

Finish: SSS, PSS

LRV: 45

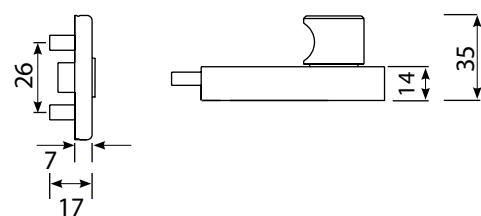
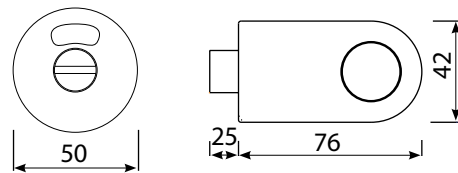

Indicator Bolts



T201– Disabled Indicator Bolt

L/H, R/H

Suitable for 13mm and 20mm board

Concealed bolt through fixings supplied

Keep supplied separately

Finish: SSS, PSS

LRV: 45

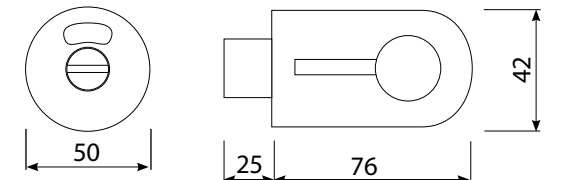

How to hand Access Hardware products

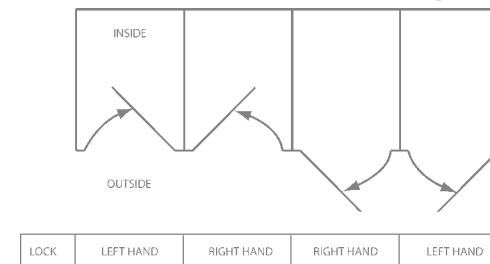

Indicator Bolts



T205 - Indicator Bolt

Suitable for 13mm and 20mm board

Surface fixing wood screws supplied

Keep supplied separately

Finish: SSS

LRV: 45

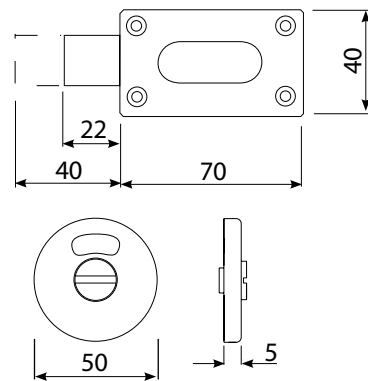
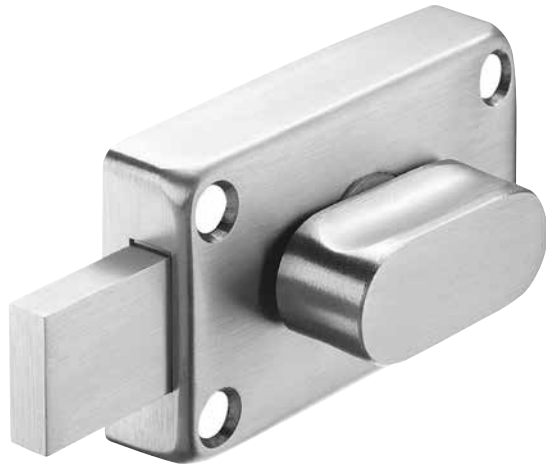

Indicator Bolts



T209 - Mortice Indicator Bolt

Suitable for flush doors up to 46mm thick

Concealed bolt through fixings supplied

Finish: SSS

LRV: 45

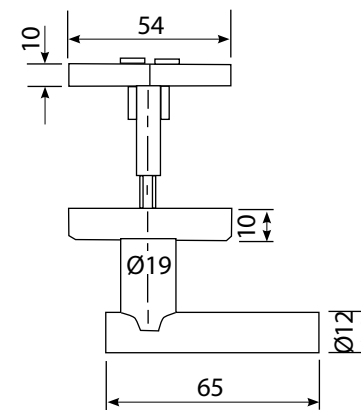

T209 / F2 Heavy Duty Mortice Lock

Suitable for doors of minimum 20mm thick



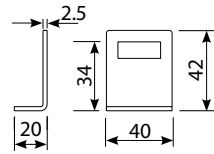
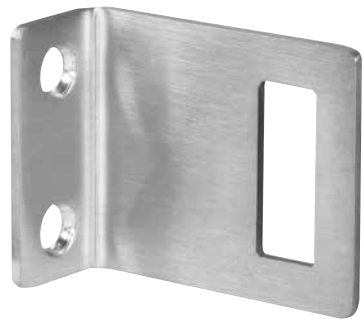

T250 - Angle Keep
Suitable for 13mm board

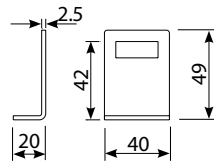

T251 - Angle Keep
Suitable for 20mm board
To be used with surface fix indicator bolts, open in doors
Use with 2 No T950 8mm rubber door buffers
Wood screws supplied
Finish: SSS, PSS

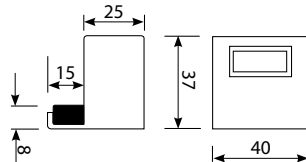

T262 - Deluxe Box Keep/Buffer
Suitable for 13mm board

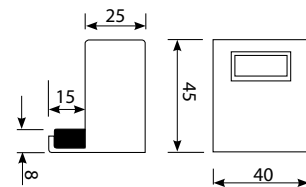

T263 - Deluxe Box Keep/Buffer
Suitable for 20mm board
To be used with surface fix indicator bolts, open in doors
Wood screws supplied
Finish: SSS, PSS

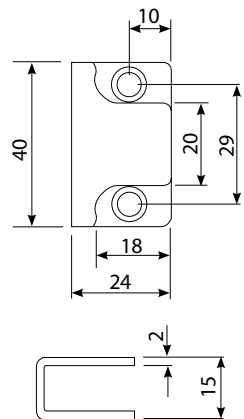

T270 - U Shaped Keep
Suitable for 13mm and 20mm board
To be used with surface fix indicator bolts, open out or flush fitting doors
Use with 2 No T951 15mm rubber door buffers on open out doors
Wood screws supplied
Finish: SSS, PSS

T950 - 8mm Rubber Door Buffer

Suitable for 13mm and 20mm board

For use with open in doors

Wood screws supplied

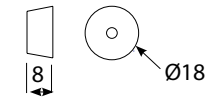

T951 - 15mm Rubber Door Buffer

Suitable for 13mm and 20mm board

For use with open out doors

Wood screws supplied

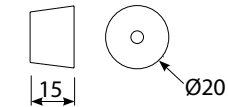

T400 - L Bracket

Suitable for 13mm board
Wood screws and plastic plugs supplied

For bolt through fixings order T194 (Pack of 6no Csk bolts and T nuts)

Finish: SSS, PSS

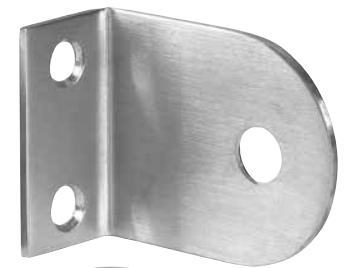
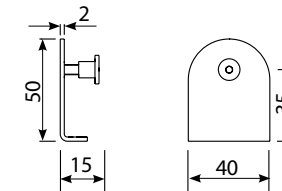

T401 - L Bracket

Suitable for 20mm board
Wood screws and plastic plugs supplied

Finish: SSS, PSS

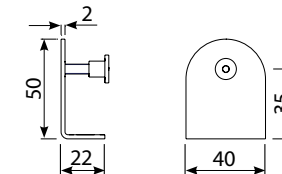

T410 - U Bracket

Suitable for 13mm board
Wood screws and plastic plugs supplied

For bolt through fixings order T194 (Pack of 6no Csk bolts and T nuts)

Finish: SSS, PSS

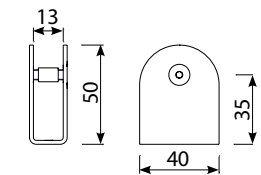

T411 - U Bracket

Suitable for 20mm board
Wood screws and plastic plugs supplied

Finish: SSS, PSS

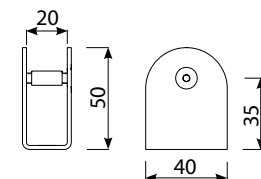

Gravity Hinge

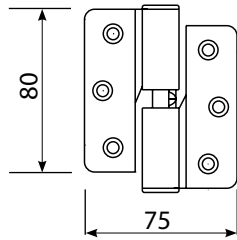

T100 – Gravity Hinge

L/H, R/H

Suitable for 13mm and 20mm board

Can be adjusted on site to hold open or hold closed

Fixings supplied separately

Finish: SSS, PSS

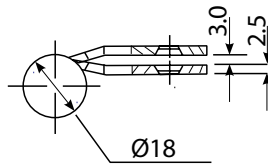

Fixings –

Fixings for 13mm board

T170 - 12no 10mm x 10 Undercut Csk Wood Screws

T190 - 8no M5 x 10mm

Csk Bolts, 8no M5 T Nuts, 4no 10mm x 10 Undercut Csk Wood Screws

Finish: SSS, PSS

Fixings for 20mm board

T171 - 12no 18mm x 10 Undercut Csk Wood Screws

T191 - 8no M5x18mm

Csk Bolts, 8no M5 T Nuts, 4no 18mm x 10 Undercut Csk Wood Screws

Finish: SSS, PSS



Gravity Hinge

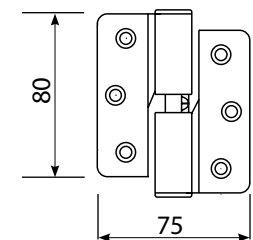

T110 – All Stainless Steel Gravity Hinge

Suitable for 13mm and 20mm board

Marine Grade 316 for higher corrosion resistance

Can be adjusted to hold open or hold closed

Fixings supplied separately

Finish: SSS

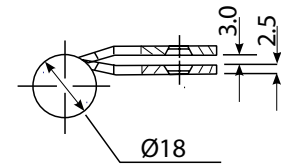

How to hand Access Hardware products

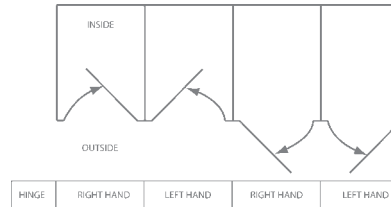

Leg Supports

T351 - Dome foot support

Suitable for 10-32mm board
 Marine Grade 316 for higher corrosion resistance
 Adjustable from 85-115mm
 Bolt through fixings and T nuts supplied
 Finish: SSS

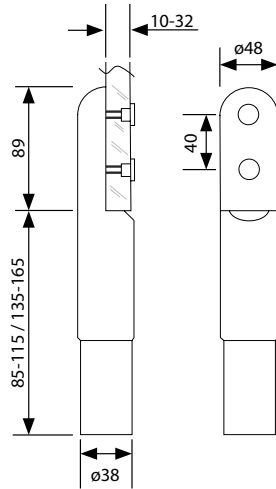

T352 - Dome Foot Support

Suitable for 10-32mm board
 Marine Grade 316 for higher corrosion resistance
 Adjustable from 135-165mm
 Bolt through fixings and T nuts supplied
 Finish: SSS

T300 - 38mm Dia Adjustable Leg Support

Suitable for 13mm board
 Adjusts from 150mm to 180mm
 Wood screws and plastic plugs supplied
 Finish: SSS, PSS

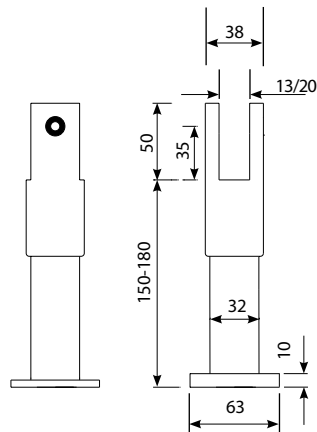

T310 - 38mm Dia Adjustable Leg Support

Suitable for 20mm board
 Adjusts from 150mm to 180mm
 Wood screws and plastic plugs supplied
 Finish: SSS, PSS

T340 - 32mm Dia 150mm Leg Support

Suitable for 13mm and 20mm board
 5no 1mm thick base packing pieces supplied for uneven floors
 Wood screws and plastic plugs supplied
 Finish: SSS, PSS

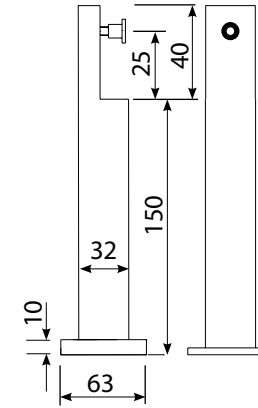

T301 - 38mm Dia Adjustable Leg Support

Suitable for 13mm board
 Adjusts from 85mm to 115mm
 Wood screws and plastic plugs supplied
 Finish: SSS

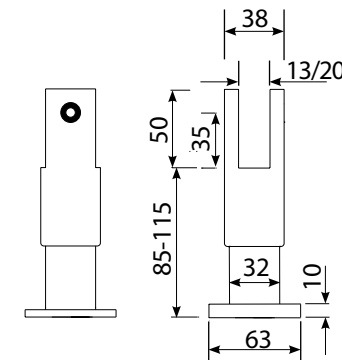

T311 - 38mm Dia Adjustable Leg Support

Suitable for 20mm board
 Adjusts from 85mm to 115mm
 Wood screws and plastic plugs supplied
 Finish: SSS

T341 - 32mm Dia 20mm Leg Support

Suitable for 13mm and 20mm board
 5no 1mm thick base packing pieces supplied for uneven floors
 Wood screws and plastic plugs supplied
 Finish: SSS

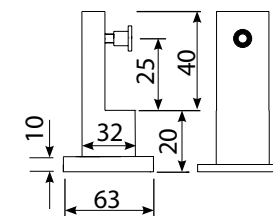

Leg Supports

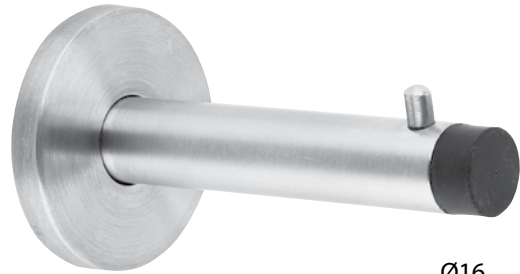

T500 - 90mm Cylindrical Coat Hook/Buffer

Suitable for 13mm and 20mm board
 Concealed Fix
 Wood screws supplied
 Finish: SSS, PSS

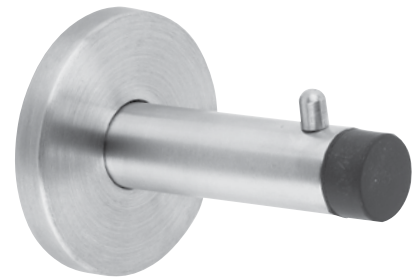
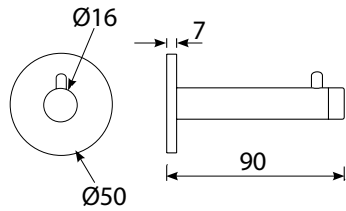

T501 - 65mm Cylindrical Coat Hook/Buffer

Suitable for 13mm and 20mm board
 Concealed Fix
 Wood screws supplied
 Finish: SSS

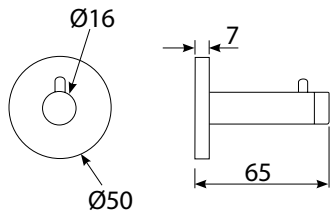

T510 - Coat Hook/Buffer

Suitable for 13mm and 20mm board
 Wood screws supplied
 Finish: SSS, PSS

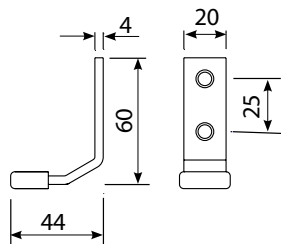

T520 - Hat and Coat Hook/Buffer

Suitable for 13mm and 20mm board
 Wood screws supplied
 Finish: SSS

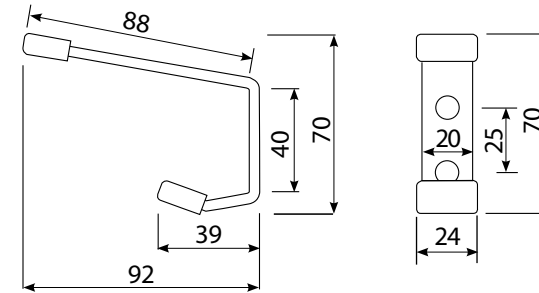

T521

Hat and coat hook, buffer

44mm Projection
 Screw fixings supplied
 Finish: SSS, PSS

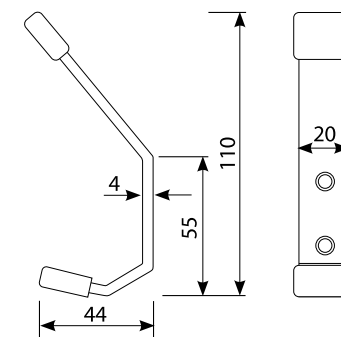

Headrail

T960 – Stainless steel Angle Headrail

Suitable for 20mm board
Available in 3m lengths
Finish: SSS, PSS

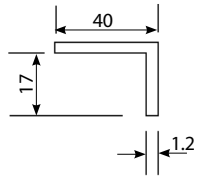

T970 – Stainless steel Channel Headrail

Suitable for 13mm board
Available in 3m lengths
Finish: SSS, PSS

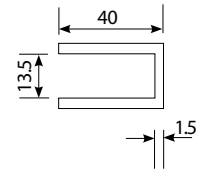

T985 – Aluminium Box section

Floor to ceiling post
Available in 4m lengths
T985A/F1 Column support pairs can be ordered separately
Finish: SAA

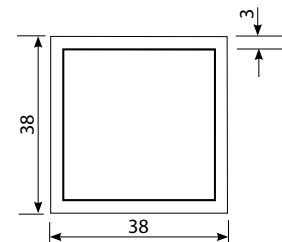

Headrail

T965 – Aluminium Angle Headrail

Suitable for 20mm board
Available in 4m lengths
Finish: SAA

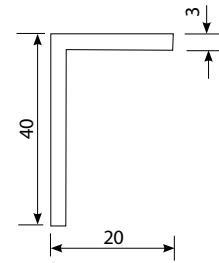

T975 – Aluminium Channel Headrail

Suitable for 13mm board
Available in 4m lengths
Finish: SAA

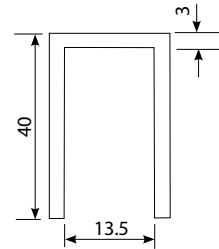

T990 – Aluminium D section Headrail

Suitable for 13-20mm board
Available in 3.5m lengths
Finish: SAA, PAA

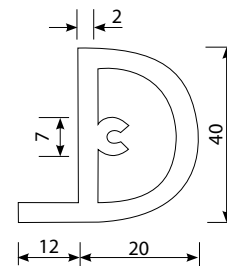

Toilet Roll Holders



T600 - Deluxe Toilet Roll Holder

Suitable for 13mm and 20mm board
 Concealed Fix
 Wood screws supplied
Finish: SSS, PSS

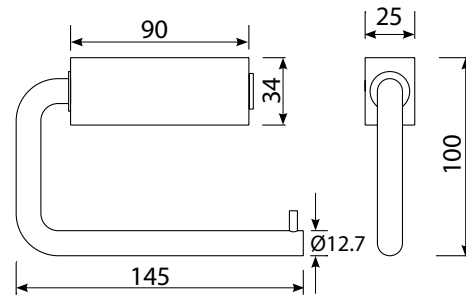

T610 - Budget Toilet Roll Holder

Suitable for 13mm and 20mm board
 Stainless Steel Roller
 Wood screws supplied
Finish: SSS, PSS

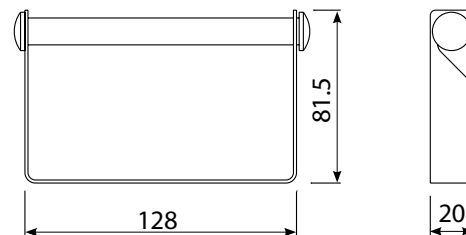

General Information

Guarantee

Access Hardware guarantees their products against defects in workmanship and materials subject to fair wear and tear in standard atmospheric conditions for a period of 25 years.

Access Hardware assumes no liability for:

- Improper installation or failure to follow fitting instructions.
- Improper maintenance or unfair wear and tear.
- Indirect or consequential loss or damage.
- Cost of removal and/or replacement.
- Cost of freight and/or travelling expenses.
- Although our stainless steel products are suitable for most applications, neither grade 304 or 316 is unconditionally guaranteed and advice should be sought from one of our representatives.

Care and Maintenance

To retain the highest corrosion resistance it is necessary to keep the surface of stainless steel clean. This can be done by wiping with a warm clean cloth using either a mild detergent or soap, then rinsing with warm clean water and drying with a towel. Carbon steel brushes or wire wool should not be used. Comprehensive instructions are available upon request.

Change of Product Specifications

As a result of continuous improvements to our products, we reserve the right to alter standard product specifications and dimensions without prior notice.



Stylishly Simple



Access Hardware Ltd

Green Lane Studley Warwickshire B80 7EY

Tel: 01527 852 948 Fax: 01527 854 192

Email: sales@accesshardware.co.uk
www.accesshardware.co.uk

Contact Distributor